

# Günther Tulip® Vena Cava Filter Set for Femoral Vein Approach

Instructions for Use

**PATIENT I.D. CARD INCLUDED**

I-IGTCFS-338-06EN



3 3 8 - 0 6 E N

## TABLE OF CONTENTS

<b>1. DEVICE DESCRIPTION .....</b>	<b>05</b>
<b>2. INTENDED USE .....</b>	<b>05</b>
<b>3. CONTRAINDICATIONS .....</b>	<b>05</b>
3.1 Filter Placement.....	05
3.2 Optional Filter Retrieval.....	05
<b>4. WARNINGS .....</b>	<b>05</b>
4.1 Filter Placement.....	05
4.2 Optional Filter Retrieval.....	05
<b>5. PRECAUTIONS .....</b>	<b>06</b>
5.1 Filter Placement.....	06
5.2 Optional Filter Retrieval.....	07
<b>6. MRI SAFETY INFORMATION.....</b>	<b>08</b>
<b>7. POTENTIAL ADVERSE EVENTS .....</b>	<b>09</b>
<b>8. CLINICAL STUDIES.....</b>	<b>09</b>
8.1 CIVC Study.....	09
8.1.1 Objectives and Design.....	09
8.1.2 Subject Accountability.....	10
8.1.3 Results.....	11
8.1.4 Endpoint Results .....	13
8.1.5 Study Conclusions and Strengths/Limitations.....	19
8.2 PRESERVE Study .....	19
8.2.1 Objectives and Design.....	19
8.2.2 Subject Accountability.....	20
8.2.3 Results.....	21
8.2.4 Primary Endpoint Results.....	22
8.2.5 Study Conclusions and Strengths/Limitations.....	24
8.3 Additional clinical studies.....	25
<b>9. INSTRUCTIONS FOR USE .....</b>	<b>25</b>
9.1 Preparation.....	25
9.2 Filter Placement.....	26
9.3 Optional Retrieval Procedure .....	26
<b>10. HOW SUPPLIED.....</b>	<b>26</b>
<b>11. REFERENCES.....</b>	<b>26</b>

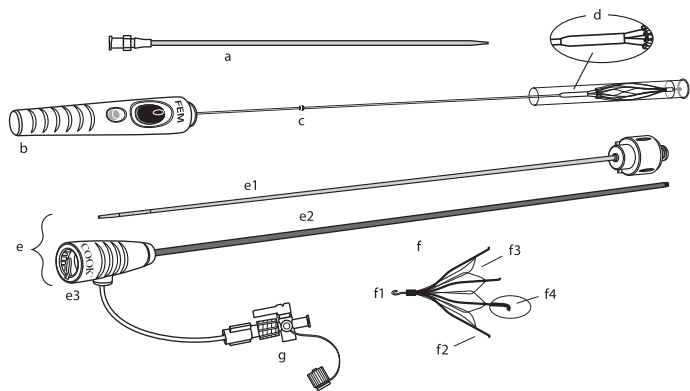

1

- a. Pre-dilator, radiopaque, hydrophilic coated, 10 French, 20 cm long
- b. Femoral filter introducer, preloaded with filter
- c. Tactile bump
- d. Femoral cup (metal mounting)

- e. Coaxial introducer system consists of:
  - e1. Introducer dilator with 8 sideports and 2 radiopaque markers at the distal end
  - e2. Introducer sheath, 7 French, 65 cm long, with radiopaque band
  - e3. Introducer sheath hub with Check-Flo® valve

- f. Günther Tulip® Vena Cava Filter (supplied preloaded)
  - f1. Hook
  - f2. Primary legs
  - f3. Secondary legs
  - f4. Anchors
- g. Three-way stopcock, plastic

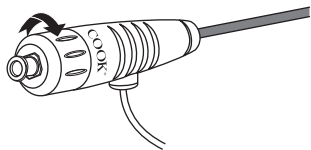

2

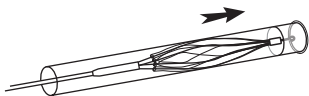

3

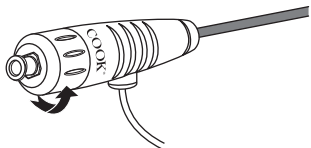

4

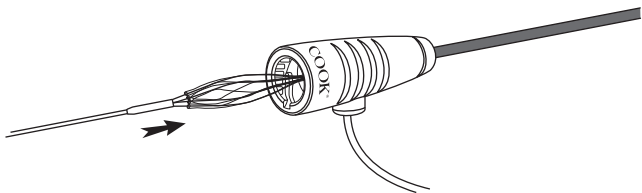

5

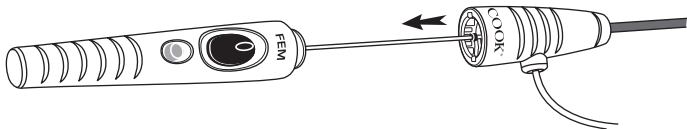

6

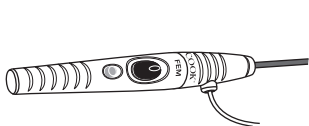

7

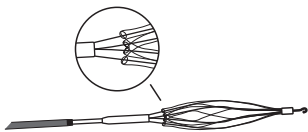

8



9

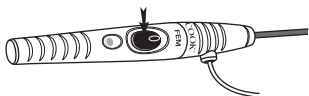

10

## GÜNTHER TULIP® VENA CAVA FILTER SET FOR FEMORAL VEIN APPROACH

Read all instructions carefully. Failure to properly follow the information provided may lead to the device not performing as intended or injury to the patient.

**STERILE – DO NOT RESTERILIZE – SINGLE USE ONLY.**

**CAUTION: US federal law restricts this device to sale by or on the order of a physician (or properly licensed practitioner).**

### 1. DEVICE DESCRIPTION

The Günther Tulip Filter Set consists of a filter composed of a paramagnetic cobalt chromium alloy (50 mm long when compressed to a diameter of 30 mm), preloaded on a femoral filter introducer; a 7 French coaxial introducer system (compatible with a 0.035 inch wire guide); and a 10 French predilator with hydrophilic coating for vessel access. The introducer dilator has eight sideports and two radiopaque markers 30 mm apart (end-to-end). The product is intended for percutaneous placement via a femoral vein in adults.

The Günther Tulip Filter implant is designed to act as a permanent filter or retrievable filter. The Günther Tulip Filter implant may be retrieved if clinically indicated; please refer to **Section 5.2, Optional Filter Retrieval** for more information.

### 2. INTENDED USE

The Günther Tulip Filter implant is intended for the prevention of recurrent pulmonary embolism (PE) via placement in the vena cava in the following situations:

- Pulmonary thromboembolism when anticoagulant therapy is contraindicated;
- Failure of anticoagulant therapy in thromboembolic diseases;
- Emergency treatment following massive PE where anticipated benefits of conventional therapy are reduced; and
- Chronic, recurrent PE where anticoagulant therapy has failed or is contraindicated.

The Günther Tulip Filter implant may be retrieved if clinically indicated; please refer to **Section 5.2, Optional Filter Retrieval** for more information.

The product is intended for percutaneous placement via a femoral vein for filtration of inferior vena cava (IVC) blood to prevent PE.

### 3. CONTRAINDICATIONS

#### 3.1 Filter Placement

- Megacava (diameter of the IVC >30 mm).
- Diameter of the IVC <15 mm.
- Extensive thrombus in the vein chosen for approach.
- Patients with risk of septic embolism.
- Use in pregnant women.
- Use in minors/pediatric patients.

#### 3.2 Optional Filter Retrieval

- Filters with significant amounts of trapped thrombus (greater than 25% of the volume of the cone).
- Patients with an ongoing high risk of PE.

### 4. WARNINGS

#### 4.1 Filter Placement

- If severe resistance is met when advancing the wire guide or the introducer system, then retract and choose a different approach. Excessive force should not be exerted.
- When power injecting contrast media, do not exceed the maximum pressure rating of 68 bar/1000 psi and flow rate of 20 mL/sec. Hand injection is also possible.
- Do not attempt to rotate the preloaded filter inside the introducer system.
- Do not re-sheath the expanded filter during femoral approach.
- Do not attempt to rotate, advance, or retract the expanded filter inside the vena cava.
- Excessive force should not be exerted in placement of the filter. If deployment of the filter is not possible, it may require a replacement of the device. If a replacement of the device is not possible or if the filter does not expand correctly, it may require additional interventions or surgical removal.
- During diagnostic imaging evaluate that the filter does not show any signs of damage or defect. If the filter is damaged, it may affect the clot trapping ability of the filter or cause an obstruction of the blood flow.

#### 4.2 Optional Filter Retrieval

- An inferior vena caval imaging evaluation for residual captured thrombus should be performed prior to attempted retrieval.
- Excessive force should not be exerted to retrieve the filter, as it may lead to filter breakage and/or harm to the patient. If retrieval of the filter is complicated, it may require additional interventions or surgical removal.

- Never attempt to re-deploy a retrieved filter.
- Please refer to **Section 8, CLINICAL STUDIES** for data regarding Günther Tulip filter retrieval.

## 5. PRECAUTIONS

- The product is intended for use by physicians trained and experienced in diagnostic and interventional endovascular techniques.
- Standard techniques for placement of vascular access sheaths, angiographic catheters, and wire guides should be employed.
- The Günther Tulip Filter Set should be used in patients with vessel diameters compatible with the associated device components.
- Product (filter or introducer system) modification or alteration is not recommended, as the product's safety and effectiveness has not been established following any modifications.
- Manipulation of products (e.g., placement and retrieval) requires imaging control.
- Before injecting any contrast media (by either power or hand injection) through the introducer dilator, ensure that the introducer sheath hub and introducer dilator are correctly connected.
- Possible allergic reactions (e.g., to cobalt, chromium, and nickel) should be considered.
- Ensure that the patient does not have impaired tolerance to general, regional, or local anesthesia to avoid adverse reactions associated with the anesthetic procedure.
- Ensure that the patient is not allergic/sensitive to contrast media since the use of contrast media during the procedure and/or during postoperative imaging may cause an allergic reaction and/or other contrast-induced harms.
- Placement in the suprarenal position have been reported. The safety and effectiveness of the filter has not been established in these patients.
- Filter tilt has been reported. Potential causes may include filter placement in IVCs with diameters larger than those specified in these Instructions for Use; improper deployment; manipulations near an implanted filter (e.g., a surgical or endovascular procedure in the vicinity of a filter); and/or a failed retrieval attempt. Excessive filter tilt may contribute to difficult or failed retrieval; vena cava wall penetration/perforation; and/or result in loss of filter efficiency.
- Vena cava wall penetration/perforation has been reported and may be either symptomatic or asymptomatic. Potential causes may include improper deployment; and/or excessive force or manipulations near an in situ filter (e.g., a surgical or endovascular procedure in the vicinity of a filter).
- Filter fracture has been reported and may be either symptomatic or asymptomatic. Fracture of a filter leg may be due to repetitive motion on a filter leg in an unusual, stressed position, such as a filter leg penetrating/perforating the IVC; or a filter leg being caught in a side branch (e.g., a renal vein). Other potential causes of filter fracture may include excessive force or manipulations near an implanted filter (e.g., a surgical or endovascular procedure in the vicinity of a filter). Retrieval of a fractured filter or filter fragments (including embolized fragments) using endovascular techniques has been reported.
- Filter or filter fragment migration and/or embolization (e.g., movement to the heart or lungs) has been reported. Filter or filter fragment movement has occurred in both the cranial and caudal direction and may be either symptomatic or asymptomatic. Potential causes may include filter placement in IVCs with diameters larger than those specified in these Instructions for Use; improper deployment; deployment into thrombus; dislodgement due to large thrombus burdens; and/or excessive force or manipulations near an in situ filter (e.g., a surgical or endovascular procedure in the vicinity of a filter).
- Increased friction and/or compression at the access site during the procedure may lead to increased risk of thrombosis at the access site.
- Follow the instructions thoroughly to ensure successful deployment, and to avoid any harm to the patient or damage to the device.
- If the introduction system or parts of the introduction system malfunctions prior to or during procedure, the device should be replaced. If the device malfunctions during procedure, perform careful replacement to avoid injuries to the access site and vessel.
- Failure to store the device correctly may result in material degradation and/or damage to the device.

### 5.1 Filter Placement

- For placement of the filter, the right femoral vein is usually preferred due to its straighter route to the vena cava. The left femoral vein can be used, but is more tortuous. Prior to choosing an approach, assess the patient's size and anatomy, and the location of any venous thromboses.
- The filter implant is supplied preloaded on the filter introducer. Do not attempt to separate the preloaded filter introducer.
- Do not attempt to reload the filter onto the filter introducer. Any attempt to do so may damage the introducer and/or the filter.
- Once the femoral cup (metal mounting; indicated as position d in **Fig. 1**) is past the tip of the

introducer sheath, the filter is fully exposed. Attempting to retract the filter at this point of the deployment sequence could damage the shape of the filter.

## 5.2 Optional Filter Retrieval

- Physician practice guidelines and published guidance from regulatory agencies recommend that patients with indwelling filters undergo routine follow-up. The risks/benefits of filter retrieval should be considered for each patient during follow-up. Refer to **Section 11, REFERENCES** for citations that include recommendations related to filter follow-up and retrieval.
- Once protection from PE is no longer necessary, filter retrieval should be considered. Filter retrieval should be attempted when feasible and clinically indicated. Filter retrieval is a patient-specific, clinically complex decision; the decision to remove a filter should be based on each patient's individual risk/benefit profile (e.g., a patient's continued need for protection from PE compared to their experience with and/or ongoing risk of experiencing filter-related complications). For all retrievable IVC filters, retrieval becomes more challenging with time, and this is commonly due to encapsulation of the filter legs or hook (in a tilted filter) by tissue ingrowth.
- **Section 8, CLINICAL STUDIES** includes data that support the safety of Günther Tulip filter retrieval.
- The filter is designed to be retrieved with the Günther Tulip® Vena Cava Filter Retrieval Set. It may also be retrieved with the CloverSnare® Vascular Retriever. Cook has not performed testing to evaluate the safety or effectiveness of filter retrieval using other retrieval systems or techniques.
- For filter retrieval, the right jugular vein is usually preferred due to its straighter route to the vena cava.
- The published clinical literature includes descriptions of alternative techniques for filter retrieval; use of these techniques varies according to physician experience, patient anatomy, and filter position. **The safety or effectiveness of these alternative retrieval techniques has not been established. Section 11, REFERENCES** includes citations that describe alternative retrieval techniques; this information is provided as reference.

## 6. MRI SAFETY INFORMATION



### MR Conditional

A patient with the Günther Tulip Vena Cava Filter may be safely scanned under the following conditions. Failure to follow these conditions may result in injury.

Parameter	Notes
<sup>1</sup> Item Name/Identification	Günther Tulip Vena Cava Filter
<sup>2</sup> Item Manufacturer	Cook Medical
<sup>3</sup> Static Magnetic Field Strength [T]	1.5 T or 3.0 T
<sup>4</sup> Maximum Spatial Field Gradient [T/m and gauss/cm]	20 T/m (2000 gauss/cm)
<sup>5</sup> RF Excitation	Circularly Polarized (CP)
<sup>6</sup> RF Transmit Coil Type	Whole body transmit coil, Head RF transmit-receive coil
<sup>7</sup> RF Power	Normal Operating Mode
<sup>8</sup> Maximum Whole Body SAR [W/kg]	2.0 W/kg
<sup>9</sup> Scan Duration	2.0 W/kg whole body average SAR for 15 minutes of continuous RF (a sequence or back to back series/scan without breaks).  Under the scan conditions defined above, the Günther Tulip Vena Cava Filter is expected to produce a maximum temperature rise of less than 5.2 °C after 15 minutes of continuous scanning.
<sup>10</sup> MR Image Artifact	The presence of this implant may produce an image artifact of 21 mm.
If information about a specific parameter is not included, there are no conditions associated with that parameter.	
Follow the MRI safety information to avoid excessive heating, torque, and/or deflection, which may cause injury to the vessel.	
Image artifacts may occur, which may prolong diagnostic time and/or require additional imaging.	

### For US Patients Only

It is recommended that patients register the conditions under which the implant can be safely scanned with the Medic Alert Foundation ([medicalert.org](http://medicalert.org)) or an equivalent organization.



## 7. POTENTIAL ADVERSE EVENTS

Potential adverse events that may occur include, but are not limited to, the following:

- Access site thrombosis/occlusion
- Air embolism
- Arrhythmia
- Back or abdominal pain
- Blood loss
- Branch vessel occlusion
- Cardiac damage
- Cardiac tamponade
- Damage to the vena cava
- Death
- Deep vein thrombosis
- Extravasation of contrast material
- Edema
- Failure of filter expansion/incomplete expansion
- Filter fracture
- Filter malpositioning
- Filter migration
- Filter or filter fragment embolization
- Hematoma at vascular access site
- Hemorrhage
- Infection at vascular access site
- Intimal tear
- Obstruction of blood flow
- Pneumothorax
- Postphlebotic syndrome
- Pulmonary embolism
- Retrieval failure
- Trauma to adjacent structures
- Unacceptable filter tilt
- Vascular trauma
- Vena cava occlusion or thrombosis
- Vena cava penetration
- Vena cava perforation
- Vena cava stenosis

## 8. CLINICAL STUDIES

### Overview of clinical studies

The Günther Tulip Vena Cava Filter was subject of three multicenter single arm Investigational Device Exemption (IDE) studies, the Cook IVC Filter Study (CIVC, described in **Section 8.1**), Predicting the Safety and Effectiveness of Inferior Vena Cava Filters (PRESERVE, described in **Section 8.2**), and IDE G000242 which was subsequently published by Hoppe et al (briefly described in **Section 8.3**). In addition, the Günther Tulip Vena Cava Filter was subject to one multicenter, single arm, study which was subsequently published by Smouse et al (briefly described in

**Section 8.3**). As detailed below, results from these studies support the safety and effectiveness of the Günther Tulip Vena Cava Filter.

### 8.1 CIVC Study

#### 8.1.1 Objectives and Design

The Cook IVC Filter Study (CIVC) was a multi-center, prospective, single arm, Investigational Device Exemption (IDE) study of Cook's commercially available permanent and retrievable IVC filters (specifically the Günther Tulip and Celect filters) that were placed in subjects for the prevention of pulmonary embolism (PE). Subjects were stratified based upon the type of filter they received (i.e., Celect or Günther Tulip). The study enrolled 473 subjects at 28 sites in the US, UK, and Australia; the Celect stratum included 324 subjects and the Günther Tulip stratum included 149 subjects. All treated subjects were scheduled for evaluation at procedure and at 3, 6 (telephone), 12, 18 (telephone), and 24 months post-procedure.

The primary objective of this IDE study was to evaluate the safety and effectiveness of Cook's commercially available permanent and retrievable IVC filters (specifically the Günther Tulip and Celect filters) in subjects in need of temporary or permanent IVC filter placement for the prevention of PE. The primary safety and effectiveness endpoints were evaluated for the Celect filter stratum. Secondary study outcomes were evaluated for each stratum and for the combined patient set.

The primary safety endpoint was the 12-month rate of freedom from major adverse events and was evaluated for the Celect stratum. Major adverse events were defined as:

- Clinical perforation: protrusion of filter legs through the wall of the IVC causing hemorrhage or hematoma or touching, impressing, or perforating another organ (e.g., liver, bowel, aorta, psoas muscle, vertebral body, lymph nodes); documented using CT and confirmed by core laboratory.
- Clinical migration: caudal or cranial movement of a filter resulting in surgical or endovascular intervention; confirmed by core laboratory.
- Clinical fracture: a loss of structural integrity (breakage or separation) of the filter identified by imaging and associated with clinical sequelae and/or requiring intervention; confirmed by core laboratory.
- Embolization of the filter or filter fragments to the heart or lungs: post-placement movement of the filter or its components to the heart or lungs; documented by imaging or autopsy and confirmed by core laboratory.
- IVC thrombotic occlusion: presence of an occluding thrombus in the IVC occurring after

filter placement (may be symptomatic or asymptomatic); documented by appropriate imaging or autopsy and confirmed by core laboratory.

- New symptomatic DVT while a filter is indwelling (confirmed by appropriate imaging and confirmed by core laboratory).
- Access site complications with clinical sequelae: arteriovenous fistula, hematoma, or bleeding requiring transfusion ( $\geq 2$  units), hospitalization (either admission or extended stay), or further treatment.
- Procedure-/device-related death: death directly attributable to the filter or filter placement or retrieval procedure itself, documented by clinical findings, imaging, or autopsy, or as adjudicated by a Clinical Events Committee.

The hypothesis for the primary safety endpoint was that at 12 months post-procedure, the rate of freedom from major adverse events will be above the prespecified performance goal of 80%.

The primary safety endpoint was tested using the Z-statistic, with Kaplan-Meier estimate for freedom from major adverse events. The primary safety endpoint was additionally tested post-hoc using the one-sided exact binomial test. Success would be considered if the lower limit of the one-sided 97.5% exact binomial confidence interval was above the performance goal.

The primary effectiveness endpoint was the rate of technical placement success (defined as deployment of a filter in a location suitable to provide sufficient mechanical protection against PE with no filter deformation, fracture, premature release, or clinical migration) and 12-month freedom from new symptomatic PE (documented by appropriate imaging and confirmed by core laboratory) while a filter is indwelling and was evaluated for the Celect stratum.

The hypothesis for the primary effectiveness endpoint was that the rate of technical placement success and 12-month freedom from new symptomatic PE while a filter was indwelling will be above the prespecified performance goal of 90%.

The primary effectiveness hypothesis was tested using the one-sided exact binomial test. Success would be considered if the lower limit of the one-sided 97.5% exact binomial confidence interval was above the performance goal.

The secondary endpoints included the rate of technical placement success and 12-month freedom from new symptomatic PE while a filter is indwelling; the rate of 12-month freedom from MAEs; and the rate of 12-month freedom from Grade 2 (i.e., filter strut entirely outside of the IVC lumen and within the retroperitoneum as evidenced by a "halo" of retroperitoneal fat around axially viewed strut) or

Grade 3 (i.e., filter strut is touching, impinging, or perforating another organ) filter leg interaction with the IVC, filter migration, filter fracture, and filter embolization. Secondary endpoints were evaluated for the individual stratum and the combined patient population. Various secondary measures, including several device safety measures, placement procedure related measures, and filter retrieval measures, were also evaluated.

### 8.1.2 Subject Accountability

In total, 473 patients were enrolled; all patients had IVC filters placed. Patient accountability is shown in **Table 1**.

**Subjects with IVC filter retrieval:** Sixty-seven percent (67%) of 473 subjects underwent filter retrieval prior to 2-years of follow-up (318/473), and compliance with the 1-month post retrieval visit was 83.8% (254/303). Thirty-four percent (34.6%) of these filter retrievals took place prior to the 3-month follow-up visit (110/318) and 94% occurred prior to 12 months of follow-up (298/318).

**Subject deaths:** A total of 73 deaths occurred during study follow-up (73/473; 15.4%). Seventy-five percent (75%) of these deaths occurred prior to 12 months of follow-up (55/73). Deaths were assessed for relatedness; 59 deaths were determined to be not related to the device or procedure, 13 deaths were unable to be determined, and one patient death was determined to be related to the device.

**Consent withdrawal or lost-to-follow-up:** Eleven percent (11%) of subjects withdrew consent or were lost-to-follow-up (51/473), with 41% occurring prior to 12 months (21/51). Over the course of the study, 22 subjects withdrew consent and 29 were lost to follow-up.

Twenty percent (20%; 97/473) of subjects remained in the study with a filter in place at 12 months. Just under 10% (9.7%; 46/473) of subjects remained in the study with a filter in place at 24 months; 87% of those completed the final study visit (40/46).

**Table 1 – Patient Accountability**

Patient Censoring	Procedure (n=473)	3 Months (n=324)	6 Months (n=177)	12 Months (n=97)	18 Months (n=68)	24 Months (n=46)	Retrieval Procedure (n=318)	1-Month Post-Retrieval (n=303)	Total
Death	29	11	15	9	7	1	0	1	73
Filter Retrieval	110	127	61	14	6	0	0	0	318
Withdrew Consent/ Lost to Follow-Up	10	8	3	6	7	4	4	9	51
Other Endpoint <sup>b</sup>	0	0	1	0	0	1	11	8	21
<b>Total</b>	<b>149</b>	<b>146</b>	<b>80</b>	<b>29</b>	<b>20</b>	<b>6</b>	<b>15</b>	<b>18</b>	<b>463</b>

All counts in the table reflect subject disposition at the end of the respective visit window.

<sup>a</sup> At each time, n reflects the number of patients eligible for the follow-up.

<sup>b</sup> Other endpoint included study filter retrieved and replaced (n=4), study filter retrieved and 1-month post-retrieval follow-up not done (n=12), patient(s) in long term care facility or hospice and unable to complete follow-up visit (n=2), patient(s) cancelled/missed follow-up (1 month, 2 year, etc.) appointment (n=3).

### 8.1.3 Results

#### Baseline Demographics

The mean age of subjects was 61 years, 57% were male, and 77% were white. Baseline venous thromboembolism status was characterized as: current DVT in 62%, current PE in 30%, a history of DVT in 34%, and history of PE in 24%. The baseline demographics were similar between the Celect and Günther Tulip stratum. **Table 2** shows patient baseline demographics.

**Table 2 – Baseline Demographics**

Characteristic		Total (N=473)	Celect (N=324)	Günther Tulip (N=149)
Age, Yrs. [Mean (SD, Range)]		61.1 (16.1; 18 - 94)	60.7 (16.4; 18 - 94)	61.9 (15.4; 20 - 92)
Gender, Male (% , n)		271 (57.3%)	184 (56.8%)	87 (58.4%)
Race				
	White	364 (77.0%)	244 (75.3%)	120 (80.5%)
	Black	57 (12.1%)	40 (12.3%)	17 (11.4%)
	Other	52 (10.9%)	40 (12.3%) <sup>a</sup>	12 (8.1%) <sup>b</sup>
Baseline Venous Thromboembolism Status <sup>c</sup>				
	History of DVT	161 (34.0%)	106 (32.7%)	55 (36.9%)
	Current DVT	279 (n=453; 61.6%)	199 (n=309; 64.4%)	80 (n=144; 55.6%)
	History of PE	115 (24.3%)	79 (24.4%)	36 (24.2%)
	Current PE	141 (29.8%)	92 (28.4%)	49 (32.9%)

<sup>a</sup> Other race includes: Hispanic or Latino (31), Asian (5), Black/Hispanic or Latino (2), Hispanic or Latino/White (1), and Asian/White (1).

<sup>b</sup> Other race includes: Hispanic or Latino (12).

<sup>c</sup> Subject could have more than baseline venous thromboembolism status.

### Indication for Filter Placement

**Table 3** summarizes the indication for filter placement, the majority of which were for current DVT (48.4%) and/or PE (20.7%) with additional indicator(s) for filter placement.

**Table 3 – Indication for Filter Placement**

Indication Details <sup>a</sup>	Total (N=473)	Celect (N=324)	Günther Tulip (N=149)
Current DVT	48.4% (229)	50.0% (162)	45.0% (67)
Current PE	20.7% (98)	19.1% (62)	24.2% (36)
Complication to anticoagulation	4.9% (23)	4.9% (16)	4.7% (7)
Contraindication to anticoagulation	40.4% (191)	37.3% (121)	47.0% (70)
Failure of anticoagulation	1.5% (7)	1.9% (6)	0.7% (1)
No contraindication to anticoagulation, but with added risk	21.4% (101)	23.5% (76)	16.8% (25)
Poor compliance with anticoagulation	0.8% (4)	1.2% (4)	0% (0)
No VTE; considered at risk:	30.9% (146)	30.9% (100)	30.9% (46)
History of prior VTE	14.8% (70)	13.6% (44)	17.4% (26)
Hypercoagulable	4.4% (21)	3.7% (12)	6.0% (9)
Recent Trauma	8.2% (39)	10.5% (34)	3.4% (5)
Surgery	20.9% (99)	18.5% (60)	26.2% (39)
Other medical condition	3.2% (15)	2.5% (8) <sup>b</sup>	4.7% (7) <sup>c</sup>
Contraindication to anticoagulation	16.9% (80)	15.4% (50)	20.1% (30)

<sup>a</sup> Subject could have more than one indication for filter placement.

<sup>b</sup> Other medical conditions included bleeding on anticoagulation (1), history of PE or DVT (1), immobilized in bed (1), metastatic cancer (1), strong family history of DVT and PE (1), previous massive PE (1), and profound anemia (2).

<sup>c</sup> Other medical conditions included cancer (1), previous DVT (1), myelofibrosis (1), prolonged immobilization (2), rectus sheath hematoma (1), and renal cell carcinoma (1).

### 8.1.4 Endpoint Results

#### Primary Safety Endpoint Results

The prespecified performance goal for the primary safety endpoint was 80%. All subjects (n=324) in the Celect stratum were evaluated for the primary safety endpoint. This analysis included all safety events (i.e., MAEs) occurring through 12 months, regardless of final patient status. Patients without a safety event through 12 months were censored in the event of filter retrieval, lost to follow-up, withdrawal, death, or an "other" endpoint. The 12-month freedom from MAE rate was 81.5% with a lower 95% confidence interval of 72.6%, failing to meet the performance goal (Table 4). The analysis failed to reject the null hypothesis [p=0.369], although the estimate for the

12-month freedom from MAE was above 80%. Many subjects were censored in the Kaplan-Meier analysis due to successful filter retrieval in the absence of a safety event (n=204), making the 12-month estimate less precise. In the post-hoc analysis, a successful filter retrieval in the absence of a safety event through 12 months was considered a successful safety result, mirroring clinical practice in which a filter is considered to have performed safely if it is placed, remains indwelling during an at-risk period, and is successfully retrieved without a safety event. In this analysis, the 12-month rate from MAE was 86.7%, with a lower 95% confidence interval of 82.5%, meeting the performance goal (Table 4).

**Table 4 – Primary Safety Endpoint Results (Celect Stratum)**

Primary Safety Endpoint	Rate (Number at risk, Number of events OR n/N)	95% CI*
12-month freedom from MAE*	81.5% (57, 32)	(72.6%, 90.4%)
Post-hoc: 12-month freedom from MAE**	86.7% (281/324)	(82.5%, 90.2%)

\* The Z-statistic was used for analyses, with Kaplan-Meier estimate for freedom from major adverse events.

\*\* The Exact binomial test model was used for analyses. The denominators are the number of subjects evaluable for the endpoint.

### Primary Effectiveness Endpoint Results

The predefined performance goal for the primary effectiveness endpoint rate was 90%. All subjects (n=324) in the Celecstratum were evaluated for

the primary effectiveness endpoint. The primary effectiveness endpoint rate for the Celecstratum was 97.8%, with a lower 95% confidence interval of 95.6%, meeting the performance goal (**Table 5**).

**Table 5 – Primary Effectiveness Endpoint Results (Celecstratum)**

Primary Effectiveness Endpoint	Rate*	95% CI*
Technical placement success and freedom from new symptomatic PE	97.8% (317/324)	(95.6%, 99.1%)

\* The Exact binomial test model was used for analyses. The denominators are the number of subjects evaluable for the endpoint.

### Secondary Endpoints

In support of the primary measures for safety and effectiveness, the secondary endpoints included evaluation of the primary safety and effectiveness endpoints for the individual stratum and the combined patient population through 12 months; outcomes for the individual elements of the endpoints were also determined. In addition, the secondary endpoints included evaluation of a 12-month composite endpoint defined as freedom from Grade 2 or Grade 3 filter leg interaction with IVC, filter migration, filter fracture, and filter embolization.

**Table 6** presents the secondary endpoints for the Celecstratum, the Günther Tulip stratum, and the total population. The outcomes support the safety and effectiveness of the Cook IVC filters. Of primary interest is whether the noted safety events occurred during the time period of filter use, which consists of the time from filter placement to filter retrieval, patient death, or a decision to leave the filter as permanent. The denominators included in **Table 6** represent how many subjects contributed to the evaluations. For the majority of the subjects, the 12-month follow-up was not performed because the filter was no longer in place (filter retrieval; 65.9%; 312/473) or evaluation was no longer possible (patient withdrew consent, lost to follow-up or death unrelated to the filter; 19.2%; 91/473). Thus the rates presented should be interpreted as representing the absence of the noted event within the time period of filter use, with a 12-month maximum.

**Table 6 – Secondary Endpoints (Total Population, Celest Stratum, Günther Tulip Stratum)**

Primary Safety Event	Total Population	Celest Stratum	Günther Tulip Stratum
<b>12-month Freedom from MAE</b>	87.9% (416/473)	86.7% (281/324)	90.6% (135/149)
Freedom from clinical perforation	93.4% (442/473)	92.7% (301/324)	94.6% (141/149)
Freedom from clinical migration	99.8% (472/473)	99.7% (323/324)	100% (149/149)
Freedom from clinical fracture	100% (473/473)	100% (324/324)	100% (149/149)
Freedom from embolization of the filter or filter fragments to the heart or lungs	100% (473/473)	100% (324/324)	100% (149/149)
Freedom from IVC thrombotic occlusion	99.6% (471/473)	99.4% (322/324)	100% (149/149)
Freedom from new symptomatic DVT while the filter is indwelling	95.1% (450/473)	94.8% (307/324)	96.0% (143/149)
Freedom from access site complications with clinical sequelae	100% (473/473)	100% (324/324)	100% (149/149)
Freedom from procedure-device-related death	100% (473/473)	100% (324/324)	99.3% (148/149)
<b>Technical placement success and 12-month Freedom from new symptomatic PE while a filter is indwelling</b>	98.1% (464/473)	97.8% (317/324)	98.7 (147/149)
Technical placement success	98.9% (468/473)	98.8% (320/324)	99.3% (148/149)
12-month freedom from new symptomatic PE while a filter is indwelling	96.9% (127/131)	96.6% (85/88)	97.7% (42/43)
<b>12-month Freedom from Grade 2 or Grade 3 filter leg interaction with IVC, filter migration, filter fracture, and filter embolization</b>	85.6% (405/473)	84.6% (274/324)	87.9% (131/149)

The bolded endpoints were prespecified secondary endpoints in the study protocol. The other categories were individual components of the endpoints.

## Secondary Measures

The secondary measures reported include individual components of the primary effectiveness endpoint and primary safety endpoint, as well as other device-related measures. These individual outcome measures included freedom from new symptomatic pulmonary embolism, freedom from clinical perforation, freedom from symptomatic clinical perforation, freedom from a filter leg perforating an adjacent organ, freedom from a filter with a leg >5 mm beyond the column of contrast, freedom from filter embolization, freedom from IVC thrombotic occlusion, freedom from new symptomatic DVT while a filter is indwelling, freedom from procedure- and device-related death, freedom from access site complications with clinical sequelae, freedom from filter fracture, and freedom from filter migration >20 mm. **Table 7** shows Kaplan-Meier estimates for the total study population, as well as the number of patients at risk and the number of events, for these secondary measures at protocol-defined follow-up time points; Kaplan-Meier analysis provides an estimate of cumulative survival (i.e., the probability that a patient is event-free over time). For freedom from clinically significant pulmonary

embolism, Kaplan-Meier analysis indicated a 99.5% probability that a patient is free from experiencing a new symptomatic pulmonary embolism at 3 months (with 360 patients at risk or still in the study and not yet experienced a new symptomatic pulmonary embolism, and 2 events of new symptomatic pulmonary embolism through 3 months) and a 98.5% probability that a patient is free from experiencing new symptomatic pulmonary embolism at 24 months (with 26 patients at risk and 4 events of new symptomatic pulmonary embolism through 24 months). **Table 8** and **Table 9** show Kaplan-Meier estimates for the Celest stratum and Günther Tulip stratum, respectively; outcomes were similar between the two strata.

Finally, filter retrieval measures were reported. In total, 335 retrieval attempts were reported and 318 retrieval attempts were successful. Failed retrieval attempts (17 attempts in 15 patients) were attributed to hook embedded in the vessel (n=11), hook oriented towards the vessel wall and unable to grasp (n=9), excessive growth at the filter legs (n=2), and other (n=3; included ingrowth of intima into struts of the filter, unable to reach the filter hook with the snare,

and hook oriented towards vessel wall and patient intolerant of procedure). One patient required surgical retrieval of a Celect filter following multiple unsuccessful endovascular retrieval attempts.

**Table 7 – Secondary Measures (% Patients Free from Experiencing Each Event) - Total Population**

Endpoint	Kaplan-Meier Estimate (Number of patients at risk, Number of events)				
	3 months	6 months	12 months	18 months	24 months
Freedom from new symptomatic pulmonary embolism while a filter is indwelling	99.5 (360, 2)	99.1 (187, 3)	98.5 (96, 4)	98.5 (60, 4)	98.5 (26, 4)
Freedom from clinical perforation	98.4% (358, 7)	97.2% (186, 11)	89.1% (90, 20)	60.5% (38, 45)	50.1% (16, 49 <sup>a</sup> )
Freedom from symptomatic filter leg interaction with the IVC	99.8% (362, 1)	99.8% (189, 1)	99.0% (98, 2)	99.0% (62, 2)	99.0% (28, 2)
Freedom from a filter with a leg perforating another organ	100% (362, 0)	99.7% (188, 1)	99.7% (98, 1)	97.4% (61, 3)	91.7% (28, 5)
Freedom from a filter with a leg >5 mm beyond the column of contrast	99.5% (361, 2)	99.5% (188, 2)	98.6% (97, 3)	91.7% (56, 9)	89.1% (27, 10 <sup>b</sup> )
Freedom from filter embolization	100% (362, 0)	100% (189, 0)	100% (98, 0)	100% (62, 0)	100% (28, 0)
Freedom from IVC thrombotic occlusion	99.1% (360, 4)	98.8% (186, 5)	97.5% (94, 7)	97.5% (60, 7)	97.5% (27, 7)
Freedom from new symptomatic deep vein thrombosis	96.5% (350, 15)	93.8% (174, 22)	93.2% (89, 23)	89.4% (54, 26)	89.4% (23, 26)
Freedom from procedure or device related death	99.8% (362, 1)	99.8% (189, 1)	99.8% (98, 1)	99.8% (62, 1)	99.8% (28, 1)
Freedom from access site complications with clinical sequelae	100% (362, 0)	100% (189, 0)	100% (98, 0)	100% (62, 0)	100% (28, 0)
Freedom from filter fracture	100% (362, 0)	100% (189, 0)	100% (98, 0)	98.9% (61, 1 <sup>c</sup> )	98.9% (27, 1)
Freedom from filter migration >20mm	100% (358, 0)	100% (186, 0)	99.0% (95, 1)	98.0% (58, 2 <sup>d</sup> )	98.0% (26, 2)

<sup>a</sup> One additional event of clinical perforation occurred after 24 months, for a total of 50 events in the study.

<sup>b</sup> Four (4) additional observations of a filter with a leg >5 mm beyond the column of contrast occurred after 24 months, for a total of 14 observations by the core laboratory.

<sup>c</sup> One (1) filter fracture was reported during a filter retrieval procedure; the retrieval attempt included use of the Günther Tulip Retrieval Set, the loop snare technique, and forceps. A filter strut subsequently embolized to the right ventricle.

<sup>d</sup> Caudal movement of a Celect and Gunther Tulip IVC filter  $\geq 20$  mm was observed on 12-month follow-up imaging, without clinical sequelae.



**Table 8 – Secondary Measures (% Patients Free from Experiencing Each Event) - Celect Stratum**

Endpoint	Kaplan-Meier Estimate (Number of patients at risk, Number of events)				
	3 months	6 months	12 months	18 months	24 months
Freedom from new symptomatic pulmonary embolism while a filter is indwelling	99.6 (256, 1)	99.0% (132, 2)	98.2% (69, 3)	98.2% (40, 3)	98.2% (15, 3)
Freedom from clinical perforation	98.0% (254, 6)	96.4% (131, 10)	89.2% (66, 16)	60.6% (28, 34)	47.1% (11, 38 <sup>a</sup> )
Freedom from symptomatic filter leg interaction with the IVC	99.7% (257, 1)	99.7% (134, 1)	98.5% (71, 2)	98.5% (42, 2)	98.5% (17, 2)
Freedom from a filter with a 3C (perforating) filter leg	100% (257, 0)	99.6% (133, 1)	99.6% (71, 1)	96.3% (41, 3)	88.1% (17, 5)
Freedom from a filter with a leg >5 mm beyond the column of contrast	99.3% (258, 2)	99.3% (134, 2)	98.0% (70, 3)	91.4% (38, 7)	87.7% (17, 8 <sup>b</sup> )
Freedom from filter embolization	100% (257, 0)	100% (134, 0)	100% (71, 0)	100% (42, 0)	100% (17, 0)
Freedom from IVC thrombotic occlusion	99.0% (255, 3)	98.6% (131, 4)	96.7% (67, 6)	96.7% (40, 6)	96.7% (16, 6)
Freedom from new symptomatic deep vein thrombosis	96.7% (249, 10)	93.4% (123, 16)	92.6% (63, 17)	89.5% (36, 19)	89.5% (13, 19)
Freedom from procedure or device related death	100% (257, 0)	100% (134, 0)	100% (71, 0)	100% (42, 0)	100% (17, 0)
Freedom from access site complications with clinical sequelae	100% (257, 0)	100% (134, 0)	100% (71, 0)	100% (42, 0)	100% (17, 0)
Freedom from filter fracture	100% (257, 0)	100% (134, 0)	100% (71, 0)	100% (42, 0)	100% (17, 0)
Freedom from filter migration >20mm	100% (254, 0)	100% (132, 0)	100.0% (70, 0)	98.6% (39, 1 <sup>c</sup> )	98.6% (15, 1)

<sup>a</sup> One additional event of clinical perforation occurred after 24 months, for a total of 39 events in the Celect stratum.

<sup>b</sup> Two (2) additional observations of a filter with a leg >5 mm beyond the column of contrast occurred after 24 months, for a total of 10 observations by the core laboratory.

<sup>c</sup> Caudal movement of a Celect IVC filter ≥20 mm was observed on 12-month follow-up imaging, without clinical sequelae.

**Table 9 – Secondary Measures (% Patients Free from Experiencing Each Event) - Günther Tulip Stratum**

Endpoint	Kaplan-Meier Estimate (Number of patients at risk, Number of events)				
	3 months	6 months	12 months	18 months	24 months
Freedom from new symptomatic pulmonary embolism while a filter is indwelling	99.3% (104, 1)	99.3% (55, 1)	99.3% (27, 1)	99.3% (20, 1)	99.3% (11, 1)
Freedom from clinical perforation	99.2% (104, 1)	99.2% (55, 1)	88.4% (24, 4)	59.8% (10, 11)	59.8% (5, 11)
Freedom from symptomatic filter leg interaction with the IVC	100% (105, 0)	100% (55, 0)	100% (27, 0)	100% (20, 0)	100% (11, 0)
Freedom from a filter with a 3C (perforating) filter leg	100% (105, 0)	100% (55, 0)	100% (27, 0)	100% (20, 0)	100% (11, 0)
Freedom from a filter with a leg >5 mm beyond the column of contrast	100% (106, 0)	100% (56, 0)	100% (27, 0)	92.6% (18, 2)	92.6% (10, 2 <sup>a</sup> )
Freedom from filter embolization	100% (105, 0)	100% (55, 0)	100% (27, 0)	100% (20, 0)	100% (11, 0)
Freedom from IVC thrombotic occlusion	99.3% (105, 1)	99.3% (55, 1)	99.3% (27, 1)	99.3% (20, 1)	99.3% (11, 1)
Freedom from new symptomatic deep vein thrombosis	96.2% (101, 5)	94.6% (51, 6)	94.6% (26, 6)	89.6% (18, 7)	89.6% (10, 7)
Freedom from procedure or device related death	99.3% (105, 1)	99.3% (55, 1)	99.3% (27, 1)	99.3% (20, 1)	99.3% (11, 1)
Freedom from access site complications with clinical sequelae	100% (105, 0)	100% (55, 0)	100% (27, 0)	100% (20, 0)	100% (11, 0)
Freedom from filter fracture	100% (105, 0)	100% (55, 0)	100% (27, 0)	96.3% (19, 1 <sup>b</sup> )	96.3% (10, 1)
Freedom from filter migration >20mm	100% (104, 0)	100% (54, 0)	96.3% (25, 1 <sup>c</sup> )	96.3% (19, 1)	96.3% (11, 1)

<sup>a</sup> Two (2) additional observations of a filter with a leg >5 mm beyond the column of contrast occurred after 24 months, for a total of 4 observations by the core laboratory.

<sup>b</sup> One (1) filter fracture was reported during a filter retrieval procedure; the retrieval attempt included use of the Günther Tulip Retrieval Set, the loop snare technique, and forceps. A filter strut subsequently embolized to the right ventricle.

<sup>c</sup> Caudal movement of a Gunther Tulip IVC filter  $\geq 20$  mm was observed on 12-month follow-up imaging, without clinical sequelae.

## 8.1.5 Study Conclusions and Strengths/

### Limitations

The CIVC Study provides safety and effectiveness data for up to two years of follow-up on 473 subjects treated with Celect or Günther Tulip vena cava filters. This large, multicenter study was intended to address FDA questions related to observed safety events for IVC filters.

The prespecified analysis for the primary safety endpoint was hindered by extensive censoring due largely to IVC filter retrieval, and less so due to patient death and subject lost-to-follow-up. The post-hoc analysis provided a clinically meaningful reflection of the primary safety rate. The 12-month freedom from MAE rate was 81.5%, with a lower 95% confidence interval of 72.6%, failing to meet the performance goal of 80%. The post-hoc primary safety endpoint rate was 86.7% (281/324).

The primary effectiveness endpoint rate was 97.8% (317/324) and met the prespecified performance goal of 90%. Of note, the 12-month rate of freedom from new symptomatic PE was 96.6% (85/88) and contributed to the primary effectiveness outcome.

The CIVC Study results largely confirm previously reported expected rates for filter complications, including filter embolization, clinically significant perforation, new DVT, IVC thrombotic occlusion, and SAEs.

## 8.2 PRESERVE Study

### 8.2.1 Objectives and Design

PRESERVE (Predicting the Safety and Effectiveness of Inferior Vena Cava Filters) was a multi-center, prospective, open-label investigation of commercially available inferior vena cava (IVC) filters that were placed in subjects for the prevention of pulmonary embolism (PE). The study enrolled 1,429 subjects at 54 US sites. All treated subjects were scheduled for evaluation at procedure and at 3, 6 (phone), 12, 18 (phone), and 24 months post-procedure.

The primary objective of this investigational device exemption (IDE) study was to evaluate the safety and effectiveness of commercially available IVC filters (retrievable and permanent) in subjects with a clinical need for mechanical prophylaxis of PE with an IVC filter.

The following filters were evaluated in the PRESERVE Study:

1. ALN Vena Cava Filter (with and without hook; ALN Implants Chirurgicaux)
2. Option™ Elite Retrievable Vena Cava Filter (Argon Medical Devices Inc., designed and manufactured by Rex Medical)
3. VenaTech® LP and VenaTech® Convertible™ Vena Cava Filter (B Braun Interventional Systems, Inc.)

4. DENALI™ Vena Cava Filter (DL900F, DL900J; Bard Peripheral Vascular, Inc.)
5. Günther Tulip® Vena Cava Filter (Cook Medical)
6. Cordis OPTease™ Retrievable Vena Cava Filter and Cordis TRAPEASE™ Permanent Vena Cava Filter (Cordis Corporation)
7. Crux® Vena Cava Filter System (Volcano Corporation; discontinued after only 7 subjects were enrolled)

The Primary Safety Endpoint was a composite that included freedom from:

- Clinically significant perforation after successful vena cava filter placement (protrusion of filter legs through the wall of the IVC causing hemorrhage or hematoma or touching, impressing, or perforating another organ [e.g., liver, bowel, aorta, psoas muscle, vertebral body, or lymph nodes] or that triggers the decision to remove the filter or requiring the other intervention; confirmed by imaging) within the first 12 months.
- Vena cava filter embolization (movement of the filter or its components to a distant anatomic site completely out of the target zone after successful vena cava filter placement; confirmed by imaging) within the first 12 months.
- Caval thrombotic occlusion (presence of an occluding thrombus in the IVC after filter insertion and documented by ultrasound, computed tomography, magnetic resonance imaging, venography, or autopsy; this may be symptomatic or asymptomatic after successful vena cava filter placement) within the first 12 months.
- New deep vein thrombosis (DVT; lower extremity DVT that is confirmed present where it had not been present previously and that occurs after the placement of the vena cava filter) within the first 12 months.
- Filter-related serious adverse events (SAEs) within the peri-operative period (the peri-operative period was ≤30 days post-filter placement).

The hypothesis for primary safety was that at 12-months post-procedure, the rates of freedom from clinically significant perforation, freedom from filter embolization, freedom from caval thrombotic occlusion, freedom from new DVT and freedom from filter-related SAEs will be above the prespecified performance goal of 80%.

The Primary Effectiveness Endpoint was a composite of the following components assessed at 12 months in subjects with an IVC filter in-situ or at 1-month post-retrieval (whichever occurred first):

- Procedural and technical success (deployment of the initial vena cava filter such that the vena cava filter is judged suitable for mechanical protection against PE, and placement of second vena cava

filter to address any anatomic variation without clinically significant perforation, vena cava filter embolization, or insertion problems).

- Freedom from clinically significant PE (new symptomatic PE confirmed by appropriate imaging).

The hypothesis for primary effectiveness was that at 12-months post-procedure in-situ or 1-month post-retrieval (whichever comes first) the rates of procedural/technical success and freedom from PE will be above the prespecified performance goal of 90%. Both hypotheses were tested using the one-sided exact binomial test. For each hypothesis, success would be considered if the lower limit of the one-sided 95% exact binomial confidence interval was above the performance goal.

Various secondary endpoints, including several device safety measures, procedure related complications, and filter retrieval, were also evaluated.

All endpoint assessments were based on site reported events. A Clinical Events Committee was responsible for standardized adjudication of the following safety events: PE, caval thrombotic occlusion, DVT, clinically significant perforation, retroperitoneal hematoma, adjacent organ penetration, unanticipated adverse device effects. CEC adjudications were used if there was a discrepancy with the site reported data. Death, filter embolization, and peri-operative SAEs were not adjudicated by the CEC.

### 8.2.2 Subject Accountability

In total, 1,421 of 1,429 enrolled subjects had IVC filters placed. Two (2) subjects died after enrollment, but before filter placement, and 6 subjects experienced treatment failures (i.e., failure to implant the IVC filter). Patient accountability is shown in **Table 10**. Results for the 1,421 patients that underwent IVC filter placement are summarized below.

**Subjects with IVC filter retrieval:** Forty-nine percent (49%) of 1,421 subjects underwent filter retrieval prior to 2-years of follow-up (690/1,421), and compliance with the 1-month post-retrieval visit was 86% (585/690). Fifty one percent (51%) of these filter retrievals took place prior to the 3-month follow-up visit (351/690), and 94% occurred prior to 12 months of follow-up (647/690).

**Subject deaths:** Almost 24% of subjects died prior to the 24-month follow-up or 1-month post-retrieval visit (337/1,421). Fifty two percent (52%) of these deaths occurred prior to the 3-month visit (174/337), and 85%, prior to 12 months of follow-up (286/337). Deaths were assessed for relatedness; 321 deaths were determined to not be device-related, 14 deaths were determined to be possibly device-related, 1 death was determined to be definitely device-related, and 1 death had missing relatedness information.

**Consent withdrawal or lost-to-follow-up:** Fifteen percent (15%) of subjects withdrew consent or were lost-to-follow-up (207/1,421), with 52% occurring within the first 3 months (108/207) and 85% (176/207) prior to 12 months follow-up. Over the course of the study, 110 subjects withdrew consent, and 99 were lost-to-follow-up.

#### 12 Month Patient Accountability – CT Imaging:

Subjects receiving a filter at the index procedure were to complete a CT scan at 12 months if the filter was not retrieved. Approximately 22% (312/1,421) of subjects remained in the study with a filter in place at 12 months. Among these 312 subjects, 199 (63.8%) had a CT scan at 12 months. Among all subjects that received a filter, 14.0% (199 subjects) of subjects had a CT scan at 12 months.

#### 24 Month Patient Accountability – CT Imaging:

Subjects receiving a filter at the index procedure were to complete a CT scan at 24 months if the filter was not retrieved. Just under 14% (193/1,421) of subjects remained in the study with a filter in place at 24 months. Among these 193 subjects, 104 (53.9%) had CT scans at 24 months. Among all subjects that received a filter, 7.3% (104 subjects) of subjects had a CT scan at 24 months.

**Table 10 – Patient Accountability**

Patient Censoring	Procedure (n=1429)	3 Months (n=788)	6 Months (n=501)	12 Months (n=312)	18 Months (n=241)	24 Months (n=193)	1-Month Retrieval (n=684)	Total
Treatment Failure	6							6
Death	174	54	58	29	18	0	4	337
Filter Retrieval	351	200	96	31	12	0	0	690
Withdrew Consent/ Lost to Follow-Up	108	33	35	11	18	0	2	207
<b>Total</b>	<b>639</b>	<b>287</b>	<b>189</b>	<b>71</b>	<b>48</b>	<b>0</b>	<b>6</b>	<b>1240</b>

All counts in the table reflect subject disposition at the end of the respective visit window.

<sup>a</sup> At each time, n reflects the number of patients eligible for the follow-up.

### 8.2.3 Results

#### Baseline Demographics

The mean age of subjects was 62.7 years, 53% were male, and 78% were white. Seventy-one

percent (71.7%) of subjects had current venous thromboembolism (VTE) and 34.3% of subjects had a history of VTE. **Table 11** shows patient baseline demographics.

**Table 11 – Baseline Demographics**

Characteristic	N = 1421
Age, Yrs. [Mean (SD, Range)]	62.7 (14.7; 18.5 - 98.4)
Gender, Male (% , n)	759 (53.4%)
Race	
White	1,102 (77.6%)
Black	213 (15.0%)
Other <sup>a</sup>	106 (7.5%)
Baseline Venous Thromboembolism Status	
Current VTE	1,019 (71.7%)
History of VTE	488 (34.3%)
Neither current nor a history of VTE	127 (8.9%)

<sup>a</sup> Other race includes: Asian (n=11), Native American or Alaskan Native (n=1), Native Hawaiian or Pacific Islander (n=1), other (n=70), more than one race (n=2), and unknown (n=21).

#### Indication for Filter Placement

In total, 1,421 of the 1,429 subjects had study filters placed. **Table 12** shows the indication for filter placement, the majority of which were for contraindication to anticoagulation (71.8%).

**Table 12 – Indication for Filter Placement**

Indication	Total Number of Subjects (n=1421)
Contraindication to or complication of anticoagulation	72.2% (1,026)
Failure of anticoagulation	9.4% (133)
Prophylaxis in the absence of DVT or PE	8.9% (126)
Placed as part of thrombolysis procedure	6.3% (90)
Additional protection for patient receiving anticoagulation	3.2% (46)

### 8.2.4 Primary Endpoint Results

#### Primary Safety Endpoint Results

Primary safety event rates were calculated for living subjects with the IVC filter in-situ at 12-months (i.e., IVC filter not removed, and patient had not died, withdrawn, or been lost to follow-up).

The prespecified performance goal for the primary safety endpoint was 80%. In total, 293 subjects were

evaluable for the primary safety endpoint when evaluating living subjects who reached 12-months follow-up, excluding subjects who died, were withdrawn, were lost to follow-up or had their IVC filter removed prior to 12-months (whether or not they had a prior safety event). The primary safety endpoint rate was 89.4%, with a lower 95% confidence interval of 85.3%, meeting the performance goal (see **Table 13**).

**Table 13 – Primary Safety Endpoint Results\***

Primary Safety Endpoint Event	Rate**	95% CI**
<b>Freedom from Primary Safety Event Rate at 12-months</b>	<b>89.4% (262/293)</b>	<b>(85.3%, -)</b>
Freedom from Clinically Significant Perforation	98.6% (289/293)	(96.5%, 99.6%)
Freedom from Filter Embolization	100.0% (293/293)	(98.8%, 100.0%)
Freedom from Caval Thrombotic Occlusion	98.6% (289/293)	(96.5%, 99.6%)
Freedom from New Deep Vein Thrombosis	91.5% (268/293)	(87.7%, 94.4%)
Freedom from SAEs possibly, probably, or definitely related to filter within Peri-Operative Period***	97.8% (1264/1292)	(96.9%, 98.6%)

\* Excludes subjects who had died, withdrawn, or been lost to follow-up or had the IVC filter removed prior to 12-months (whether or not they had a prior safety event).

\*\* The Exact binomial test model was used for analyses. The denominators are the number of subjects evaluable for the endpoint.

\*\*\* SAEs possibly, probably, or definitely related to the filter.

#### Primary Effectiveness Endpoint Results

Primary effectiveness event rates were calculated for living subjects with the IVC filter in-situ at 12-months or 1-month post-retrieval, whichever occurred first (i.e., patient had not died, withdrawn, or been lost to follow-up prior to the 12-month visit or had their filter retrieved within 12 months and did not miss the 1-month post-retrieval visit).

The pre-defined performance goal for the primary effectiveness endpoint event rate was 90%. In total, 829 subjects were evaluable for the primary effectiveness endpoint. The primary effectiveness endpoint rate was 96.4%, with a lower 95% confidence interval of 94.9%, meeting the performance goal (see **Table 14**).

**Table 14 – Effectiveness Endpoint Rate**

Endpoint Event	Rate*	95% CI*
<b>Primary Effectiveness Event Rates at 12-months in-situ or 1-month post-retrieval</b>	96.4% (799/829)	(94.9%, -)
Procedural and technical success at time of procedure	98.0% (1,393/1,421)	(97.2%, 98.7%)
Freedom from clinically significant PE	98.3% (815/829)	(97.2%, 99.1%)

\* The Exact binomial test model was used for analyses. The denominators are the number of subjects evaluable for the endpoint.

### Additional Measures

The secondary measures reported include individual components of the primary effectiveness endpoint and primary safety endpoint, as well as other device-related measures. These individual outcome measures included freedom from clinically significant pulmonary embolism, freedom from caval thrombotic occlusion, freedom from new deep vein thrombosis, freedom from clinically significant perforation, freedom from adjacent organ perforation, freedom from filter perforation >5 mm outside the cava wall, freedom from filter fracture, freedom from filter embolization, freedom from filter migration >20 mm, and freedom from SAEs possibly, probably, or definitely related to the filter within the peri-operative period.

Notably, the primary safety endpoint analysis did not include all safety events that occurred since subjects who died, were withdrawn, were lost to follow-up, or had a filter removed prior to 12 months were not counted towards the primary safety endpoint rate. Therefore, **Table 15** shows Kaplan-Meier estimates, as well as the number of patients at risk and the number of events, for the individual outcome measures at the protocol-defined follow-up time points; Kaplan-Meier analysis provides an estimate of cumulative survival (i.e., the probability that a patient is event-free over time). For freedom from clinically significant pulmonary embolism, Kaplan-Meier analysis indicated a 98.7% probability that a patient is free from experiencing clinically significant pulmonary embolism at 3 months (with 819 patients at risk or still in the study and not yet experienced clinically significant pulmonary embolism, and 16 events of clinically significant pulmonary embolism through 3 months) and a 96.2% probability that a patient is free from experiencing clinically significant pulmonary embolism at 24 months (with 192 patients at risk and 27 events of clinically significant pulmonary embolism through 24 months).

Finally, filter retrieval measures were reported. In total, 693 filters were retrieved; 690 of 706 retrieval attempts (assessed per subject) were successful. Some subjects underwent multiple retrieval attempts due to deferred or unsuccessful retrieval attempts, thus a subject may

have one or multiple failed retrieval attempts. Failed retrieval attempts (39 attempts in 36 subjects) were attributed to an inability to engage the filter (n=13), an inability to detach the filter hook from the wall (n=8), thrombus detected in the filter or components (n=12), filter unable to be removed using planned approach (n=2), unsuitable position of filter (n=2), required imaging could not be obtained (n=1), or physician decision not to remove (n=1). Among the 693 IVC filter retrievals, there was one death resulting from an innominate vein injury.

**Table 15 – Kaplan-Meier Estimates for Secondary Endpoints**

Endpoint	Kaplan-Meier Estimate (Number of patients at risk, Number of events)				
	3 months	6 months	12 months	18 months	24 months
Freedom from clinically significant pulmonary embolism	98.7 (819, 16)	97.8 (505, 22)	96.9 (310, 25)	96.6 (237, 26)	96.2 (192, 27)
Freedom from clinically significant perforation	99.9 (830, 1)	99.7 (516, 2)	99.2 (319, 4)	97.7 (242, 8)	96.2 (196, 11)
Freedom from adjacent organ perforation	100 (830, 0)	99.8 (516, 1)	99.3 (319, 3)	98.6 (243, 5)	97.6 (198, 7)
Freedom from filter perforation >5mm outside apparent cava wall	99.7 (829, 3)	99.3 (516, 6)	98.4 (318, 9)	94.6 (239, 20)	93.7 (194, 22)
Freedom from filter embolization	99.7 (828, 3)	99.6 (517, 4)	99.6 (321, 4)	99.6 (246, 4)	99.6 (201, 4)
Freedom from caval thrombotic occlusion	99.0 (822, 11)	98.3 (510, 15)	98.3 (317, 15)	97.9 (242, 16)	97.1 (197, 18)
Freedom from new deep vein thrombosis	95.2 (789, 55)	93.3 (477, 67)	91.8 (294, 73)	89.2 (217, 80)	89.2 (179, 80)
Freedom from SAEs possibly, probably, or definitely related to filter within peri-operative period	97.9 (815, 28)	97.9 (507, 28)	97.9 (315, 28)	97.9 (241, 28)	97.9 (196, 28)
Freedom from filter fracture	99.7 (828, 3)	99.5 (517, 4)	99.5 (321, 4)	99.5 (246, 4)	99.1 (201, 5)
Freedom from filter migration >20mm	99.8 (829, 3)	99.8 (516, 3)	99.8 (320, 3)	99.8 (245, 3)	99.8 (200, 3)

### 8.2.5 Study Conclusions and Strengths/ Limitations

The PRESERVE Study provides safety and effectiveness data for up to two years of follow-up on 1,421 subjects treated with commercially available retrievable and permanent IVC filters in US subjects. This large, multicenter study was intended to address FDA questions related to observed safety events for IVC filters.

The primary safety endpoint rate was 89.4% (262/293), which met the prespecified performance goal of 80%. However, it is important to note that this rate excluded subjects who died, were withdrawn, were lost to follow-up or had the IVC filter removed prior to 12-months (whether or not they had a prior safety event). Thus, there was extensive censoring due to patient death, IVC filter retrieval, and subject lost-to-follow-up, which resulted in only 293 of 1,421

subjects (21%) evaluable at 12-months to assess the primary safety endpoint event rate. Given that only subjects who were still in the study at 12 months were included, subjects who experienced a primary safety endpoint event and then had a filter removed were not counted against the primary safety endpoint. For example, there were 4 instances of embolization of IVC filters or filter components, but this is not reflected in **Table 13**, which reports Freedom from Filter Embolization as 100% (293/293), since these filter embolizations occurred before IVC filter removal prior to 12-months. Kaplan Meier estimates for freedom from secondary measures for all subjects are shown in **Table 15**. Study endpoints were determined by site assessment, which could underestimate outcomes. Another limitation of the study is that only 14.0% of the 1,421 subjects that received a filter (or 63.8% of subjects still in the study at 12 months) had CT scans at 12 months and only 7.3% (or 53.9% of subjects still



in the study at 24 months) had CT scans at 24 months. The Primary Effectiveness Endpoint rate was 96.4% (799/829) and met the prespecified performance goal of 90%. Of note, the 12-month rate of freedom from new pulmonary embolism was 98.3% (815/829) and contributed to the primary effectiveness outcome. The results from the PRESERVE Study, especially when assessed for the full population and not just those in the study at 12 months, are consistent with previously reported rates for filter complications, including filter embolization, clinically significant perforation, new DVT, caval thrombotic occlusion, and SAEs.

### 8.3 Additional clinical studies

The safety of retrieving the Günther Tulip Vena Cava Filter was evaluated in a multicenter single arm Investigational Device Exemption study in the US in which filters were placed in 41 patients (female (n=19); male (n=22)). This study was published by Hoppe et al. A multicenter single arm study in the US in which filters were placed in 554 patients also evaluated device retrievability. This study was published by Smouse et al. These publications are summarized below (**Table 16**) and support the successful retrievability of the Günther Tulip Vena Cava Filter.

**Table 16 – Summary of Clinical Data from Additional Clinical Studies Günther Tulip Vena Cava Filter**

Reference	Filters Inserted, n	Retrieval Attempts, n	Successful Retrievals, n (%)	Range, days	Mean, days	Filter-Related Adverse Events <sup>a</sup>
Hoppe H, Nutting CW, Smouse HR, et al. Günther Tulip Filter Retrievability Multicenter Study Including CT Follow-up: Final Report. J Vasc Interv Radiol. 2006;17:1017-1023 <sup>a</sup>	42	23	23 (100%)	2-14	11.1	Filter migration >2 cm after suprarenal placement (n=1), PE with filter in place and occlusive thrombus (n=1), and new IVC stenosis <20% after retrieval (n=1)
Smouse HB, Rosenthal D, Van Ha T, et al. Long-term Retrieval Success Rate Profile for the Günther Tulip Vena Cava Filter. J Vasc Interv Radiol. 2009;20:871-877	554	275	248 (90%)	3-494	58.9	Post-retrieval IVC stenosis at retrieval (n=1) and a small PE immediately after retrieval (n=1)

<sup>a</sup> Data collected under IDE #G000242.

## 9. INSTRUCTIONS FOR USE

The product is intended for use by physicians trained and experienced in diagnostic and interventional endovascular techniques. Standard techniques for placement of vascular access sheaths, angiographic catheters, and wire guides should be employed. It is assumed that the operator will use local anesthesia, sedation, and analgesia as required.

### 9.1 Preparation

1. Flush the introducer sheath and the introducer dilator.
2. Advance the introducer dilator through the middle of the Check-Flo® valve on the introducer sheath. Secure the introducer dilator to the introducer sheath by twisting the dilator hub clockwise until a click is felt. (**Fig. 2**)
3. Remove the filter protection tube. (**Fig. 3**)

## 9.2 Filter Placement

4. Access the chosen femoral vein using the Seldinger technique.
5. Perform diagnostic imaging to confirm a single IVC, measure the IVC diameter, check for thrombus, and establish the position of the renal veins.
6. Place a supportive 0.035 inch wire guide in the IVC.
7. If necessary, dilate the puncture site with the 10 French pre-dilator.
8. Remove the pre-dilator and advance the coaxial introducer system over the wire guide until the tip of the introducer sheath lies approximately 1 cm caudal to the lowest renal vein.
9. Remove the wire guide.
10. Perform diagnostic imaging to verify the position of the introducer sheath tip (or radiopaque marker) approximately 1 cm caudal to the lowest renal vein.

**CAUTION: Before injecting contrast media by either power or hand injection through the introducer dilator, ensure that the introducer sheath hub and introducer dilator are correctly connected.**

**WARNING: When using a power injector, do not exceed the maximum pressure rating of 68 bar/1000 psi and flow rate of 20 mL/sec.**

11. When correct position is established, twist the introducer dilator hub counterclockwise and remove the introducer dilator. (Fig. 4)
  12. Place the filter introducer with the preloaded filter into the Check-Flo valve of the introducer sheath, (Fig. 5) and advance it into the introducer sheath until the Check-Flo valve contacts the tactile bump on the filter introducer. This will place the hook of the filter inside the introducer sheath at the radiopaque band. Verify that the position of the hook is inside the introducer sheath and still caudal to the renal veins.
- WARNING: Do not rotate the preloaded filter inside the introducer system.**
- WARNING: Do not exert excessive force to advance the filter through the introducer system.**
13. Stabilize the filter introducer, withdraw the introducer sheath, (Fig. 6) and connect it to the handle of the femoral introducer. (Fig. 7) At this point the filter is fully exposed, still connected to the filter introducer. (Fig. 8)

**CAUTION: Attempting to retract the filter at this point of the deployment sequence could damage the shape of the filter.**

14. Proper position can now be verified by diagnostic imaging.

**WARNING: Do not rotate the expanded filter inside the vena cava. Doing so may compromise the performance of the filter.**

**CAUTION: Injection of contrast medium must not be performed unless the femoral cup (metal mounting; indicated as position d in Fig. 1) is completely free of the introducer sheath. Use the radiopaque band of the introducer sheath for positioning.**

15. Verify that the introducer sheath hub and femoral introducer handle are connected to ensure that the femoral cup is completely free of the introducer sheath before filter release.
16. When the filter position is correct, push the red safety button to prepare filter release. (Fig. 9)
17. Push the release button completely to ensure proper release of the filter. (Fig. 10) Repositioning of the filter is no longer possible. The filter is now released.
18. Perform diagnostic imaging to verify filter position.

**NOTE:** Hospital standard of care should be followed for removing the introducer sheath and providing hemostasis to prevent bleeding at the vascular access site.

## 9.3 Optional Retrieval Procedure

The Günther Tulip Filter implant may be retrieved. The filter was designed to be retrieved with the Günther Tulip Vena Cava Filter Retrieval Set. It may also be retrieved with the CloverSnare Vascular Retriever. Please refer to the Instructions for Use provided with the Günther Tulip Vena Cava Filter Retrieval Set or the CloverSnare Vascular Retriever (not included in the filter set).

## 10. HOW SUPPLIED

Supplied sterilized by ethylene oxide gas in peel-open packages. Intended for one-time use. Do not resterilize. Sterile if package is unopened or undamaged. Do not use the product if there is doubt as to whether the product is sterile. Keep the device dry and away from sunlight. Upon removal from package, inspect the product to ensure no damage has occurred.

## 11. REFERENCES

These instructions for use are based on experience from physicians and/or their published literature, IVC filter guidelines, ISO 25539-3, and regulatory safety communications regarding IVC filters. Refer to your local Cook sales representative for information on available literature.

Recommendations related to filter follow-up and retrieval:

- Hoppe H, Nutting CW, Smouse HR, et al. Günther

Tulip Filter Retrieval Multicenter Study Including CT Follow-up: Final Report. *J Vasc Interv Radiol.* 2006;17:1017-1023.

- Smouse HB, Rosenthal D, Van Ha T, et al. Long-term Retrieval Success Rate Profile for the Günther Tulip Vena Cava Filter. *J Vasc Interv Radiol.* 2009;20:871-877.
- Kaufman JA, Barnes GD, Chaer RA, et al. Society of Interventional Radiology clinical practice guideline for inferior vena cava filters in the treatment of patients with venous thromboembolic disease: developed in collaboration with the American College of Cardiology, American College of Chest. *J Vasc Interv Radiol.* 2020;31(10):1529-1544.
- ARC-SIR-SPR 2021 practice guideline for the performance of inferior vena cava (IVC) filter placement for the prevention of pulmonary embolism. Published online 2021:1-17.
- ISO 25539-3:2011 "Cardiovascular implants – Endovascular devices – Part 3: Vena cava filters".
- Removing Retrievable Inferior Vena Cava Filters: FDA Safety Communication; Issued May 6, 2014.
- Retrievable inferior vena cava (IVC) filters – serious complications associated with attempted IVC filter retrieval. MHRA Medical Device Alert; Issued May 2, 2013.

Filter retrieval is a patient specific, clinically complex decision; the decision to remove a filter should be based on each patient's individual risk/benefit profile (e.g., a patient's continued need for protection from PE compared to their experience with and/or ongoing risk of experiencing filter-related complications). For all retrievable IVC filters, retrieval becomes more challenging with time, and this is commonly due to encapsulation of the filter legs or hook (in a tilted filter) by tissue ingrowth.

The following references include descriptions of alternative techniques for filter retrieval. **The safety or effectiveness of these alternative retrieval techniques has not been established.** Use of these techniques varies according to physician experience, patient anatomy, and filter position.

- Al-Hakim et al. The hangman technique: a modified loop snare technique for the retrieval of inferior vena cava filters with embedded hooks. *J Vasc Interv Radiol.* 2015; 26(1):107-10.
- Cho et al. Failed inferior vena cava filter retrieval by conventional method: Analysis of its causes and retrieval of it by modified double-loop technique. *Phlebology.* 2015; 30(8):549-56.
- Foley et al. A "fall-back" technique for difficult inferior vena cava filter retrieval. *J Vasc Surg.* 2012; 56(6):1629-33.
- Kuo et al. Excimer laser-assisted removal of embedded inferior vena cava filters: a single-center

prospective study. *Circ Cardiovasc Interv.* 2013; 6(5):560-6.

- Stavropoulos et al. Retrieval of Tip-embedded Inferior Vena Cava Filters by Using the Endobronchial Forceps Technique: Experience at a Single Institution. *Radiology.* 2015; 275(3):900-7.



**William Cook Europe ApS**

Sandet 6

4632 Bjaeverskov

Denmark

Phone: +4556868686

2024-03

I-IGTCFS-338-06EN

[cookmedical.com](http://cookmedical.com)

© COOK 2024